

# Applying the Americans with Disabilities Act in Work Zones: A Practitioner Guide

Fall 2012

*Developed by:*

**The American Traffic Safety Services Association**  
15 Riverside Parkway Suite 100  
Fredericksburg, VA 22406-1022  
800-272-8772

This material is based upon work supported by the  
**Federal Highway Administration**  
under Grant Agreement No. DTFH61-06-G-00004

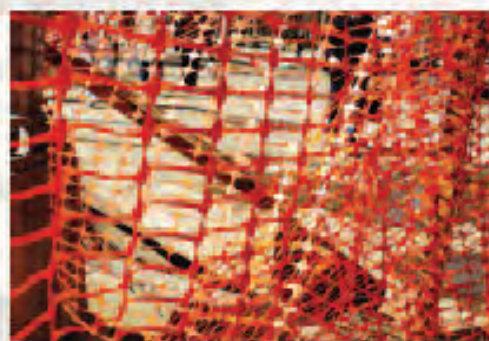

Any opinions, findings, and conclusions or recommendations expressed in this publication are those of the author(s) and do not necessarily reflect the view of the Federal Highway Administration.

# Table of Contents

<b>Introduction and Background</b> .....	<b>3</b>
Sources of Legal Authority and Best Practices .....	3
<b>Understanding the Disability Challenge</b> .....	<b>4</b>
Challenges Faced by Disabled Pedestrians .....	4
Challenges Faced by Work Zone Practitioners .....	5
<b>Approaches to Routing Pedestrians</b> .....	<b>5</b>
Maintaining Accessibility on the Current Pathway .....	6
Creating an Accessible Alternate Pathway: General Considerations .....	6
<i>Speed</i> .....	7
<i>Access to Businesses and Transit</i> .....	7
<i>Communicating with the Public</i> .....	8
<b>Physical Characteristics of an Accessible Temporary Facility</b> .....	<b>8</b>
Communication Devices .....	8
Overhead and Protrusion Protection .....	10
Channelizing Devices .....	10
<i>Handrails and Guiderails</i> .....	12
Surfaces .....	13
Temporary Curb Ramps .....	14
<i>Transitions</i> .....	14
Lighting .....	15
<b>Best Practices for Work Zone Design and Planning</b> .....	<b>15</b>
<b>Conclusions</b> .....	<b>17</b>
<b>Appendix A. National Committee on Uniform Traffic Control Devices (NCUTCD)</b> Proposed MUTCD Language .....	<b>18</b>
<b>Appendix B. Minnesota Department of Transportation Standards, Drawings, and</b> Sample Specification .....	<b>21</b>
<b>Appendix C. Florida Standard 660 Pedestrian Control For Closure of Sidewalks</b> .....	<b>28</b>
<b>Appendix D. Oregon Department of Transportation Design Guidance and Sample Layout</b> .....	<b>31</b>
<b>Appendix E. Washington State Department of Transportation Design Guidance</b> .....	<b>34</b>
<b>Appendix F. Sample Americans with Disabilities Act (ADA) Drawings</b> .....	<b>35</b>

# Introduction and Background

A basic requirement of work zone traffic control, as provided in the Manual on Uniform Traffic Control Devices (MUTCD), is that the needs of pedestrians, including those with disabilities, must be addressed in temporary traffic control plans (TCPs) in accordance with the Americans with Disabilities Act of 1990 (ADA), Title II, Paragraph 35.130. The ADA is a Federal law that requires that pedestrians with physical and/or mental disabilities be accommodated not only in completed, publicly accessible facilities, but also during times of construction or improvement. All pedestrians, including the disabled, should be provided with safe, accessible, and reasonably convenient paths that replicate as nearly as practical the most desirable characteristics of the existing pedestrian circulation facilities when temporary traffic control (TTC) zones are planned and set up.

## **MUTCD Section 6D.04:**

*If the TTC zone affects the movement of pedestrians, adequate pedestrian access and walkways shall be provided. If the TTC zone affects an accessible and detectable pedestrian facility, the accessibility and detectability shall be maintained along the alternate pedestrian route.*

## Sources of Legal Authority and Best Practices

The U.S. Access Board, an independent Federal agency devoted to the issue of accessibility for people with disabilities, develops and maintains design criteria for the built environment (including the transportation system) under the ADA Accessibility Guidelines, or ADAAG. ADAAG covers a wide variety of facilities and establishes guidelines for new construction and alterations.

The Access Board also maintains responsibility for accessibility guidelines under the Architectural Barriers Act, or ABA. The ABA requires agencies to provide access to facilities **designed, built, altered, or leased with Federal funds**. Some examples may include transit stop shelters or elevators to raised public transportation platforms. Like ADAAG, the Board's ABA accessibility guidelines apply specifically to **new construction and alterations that use Federal-aid funding**, so many construction projects will need to comply with these guidelines.

The Access Board has also drafted a set of standards that provides interim guidance for pedestrian facilities *within* the public right-of-way. These guidelines, called the Proposed Right-of-Way Accessibility Guidelines, or PROWAG, were published in the Federal Register in 2005. Although the PROWAG has not yet been fully adopted and so is not considered a "standard" with the force of law behind it, these Draft Guidelines are the currently recommended best practices and can be considered the state of the practice for those issues that are not fully addressed by the ADAAG and ABA. The PROWAG specifically states that **temporary facilities covered by its proposed standards include, but are not limited to, temporary routes around work zones**.

*Throughout this document, color-coded text boxes will be used to identify standards from the MUTCD (blue) and the ADAAG (green), best practices identified in the PROWAG (purple), and proposed language developed by the NCUTCD (pink) for inclusion in the next edition of the MUTCD (red).*

It is also worth noting that the National Committee on Uniform Traffic Control Devices (NCUTCD), a group whose sole function is to improve the quality and effectiveness of MUTCD standards, has adopted proposed language to add to the next edition of the MUTCD. The proposed language for a new section on Pedestrian Channelizing Devices was approved by the NCUTCD on June 23, 2011, so practitioners should be advised that there is a strong possibility that this language, which makes several current best practices required activities, will be adopted (see

Appendix A for the proposed new language). The table below summarizes the standards and guidance that are currently in place or may come to be in place as legal guidance to the States. As with any work zone, practitioners should check for applicable State or local standards, which will take precedence over the minimum standards provided by Federal law.

**Table 1. Summary of Federal Sources for Legal Minimum Standards and Best Practices**

Guidance Source	Legal Standard	Best Practice
Manual on Uniform Traffic Control Devices	✓	✓
Americans with Disabilities Act Accessibility Guidelines	✓	✓
Architectural Barriers Act	✓	✓
Proposed Right-of-Way Accessibility Guidelines	✓	✓
Pedestrian Channelizing Devices (NCUTCD proposed language)	✓	✓

This document uses the sources listed above to provide State and local transportation agencies with strategies and technical guidance on how to design TCPs that address pedestrian access during construction, including the needs of those with disabilities. This document:

- *Describes the challenges faced by disabled pedestrians;*
- *Outlines considerations to planning and designing strategies to manage pedestrians in a work zone; and*
- *Provides examples to further assist practitioners in setting up work zones and making them safe for all pedestrians.*

Because there is growing interest in this topic among State agencies and practitioners, several States have developed drawings, specifications, and standards as part of their State MUTCDs or other policy documents that may provide useful guidelines to all practitioners in designing accessible temporary pedestrian access routes. The appendices at the end of this document have been developed to provide samples from that information pool, with each appendix focused on a different accessibility feature; for example, Appendix B (Minnesota) addresses surfaces, Appendix C (Florida) outline a high-level view of overall work zone set up and guidance, and the drawings in Appendix D (Oregon) depict diversions and setups across smaller networks. A sample ADA drawing is also provided in Appendix F.

## Understanding the Disability Challenge

### Challenges Faced by Disabled Pedestrians

There are several types of disability that may affect a user’s ability to navigate a work zone safely, but these can be distilled down into two broad categories of users that work zone practitioners must particularly keep in mind: those with **sight impairments** and those with **mobility impairments**.

In designing accessible routes, it is important to consider the needs of disabled pedestrians in order to keep them as safe as pedestrians who are not impaired. Those with sight impairments will need a physical environment that is free of sharp edges, uneven grading, and obstructions that can cause tripping or falling hazards. Those who are mobility challenged may use canes, crutches, walkers, wheelchairs, scooters, or no assistive devices at all. Their mobility challenges generally mean they have difficulty using steps, navigating narrow pathways, turnarounds, and changes in elevation; even small elevation changes are sometimes difficult for some mobility impaired pedestrians to negotiate, which is one reason that installing ramps is essential to maintaining access.

Some of the types of safety issues a blind pedestrian will often face include:

- *Not knowing the TTC is there until they reach it;*
- *Not knowing if there is a safe alternative way to proceed (in other words, is the sidewalk closed, or has a safe pathway through the TTC been set up?);*
- *Not knowing if they should attempt to cross the street and continue by walking on the other side or if they should retrace their steps and use another route;*
- *Not knowing if a cane can provide a safe way to continue through the detour;*
- *Not knowing if there might be someone nearby who could offer them assistance; and*
- *Not knowing if barriers have exposed nails or jagged edges that can injure someone feeling their way along by hand.*

Similarly, mobility impaired pedestrians also face significant challenges, including:

- *Temporary ramps that are too steep, wobble, or don't have an adequate side guard rail to hold on to.*
- *Pathways and turns or turnarounds that are too narrow for wheelchairs, motorized scooters, or those who travel with service animal assistance.*
- *Ramps or pathways with inadequate bottom barrier protection, which, during wet weather, can allow mud to flow over the surface of the ramp or path, creating slippery conditions that can be very dangerous to those who are on crutches, canes, or walkers.*

## Challenges Faced by Work Zone Practitioners

The challenges to work zone designers or planners can be looked at from two different perspectives: the “hard” challenges, which are more quantitative in nature and include measurable characteristics such as distances, slopes, and established design parameters, and “soft” challenges, which are qualitative in nature and relate to issues such as communication and access to businesses.

However, sometimes the quantitative and qualitative needs of persons with different types of disabilities will come into conflict. For example, visually impaired people do not know where the curb line is located when there are flush curbs. On the opposite end of the spectrum, however, wheelchair or stroller users typically prefer flush curbs. The compromise is to add tactile components which allow both a flush curb and a method for the visually impaired to recognize when they are entering the street. This shows that engineers will often have to use engineering judgment to accommodate the majority of users.

The remainder of this document first discusses pedestrian routing approaches and factors to consider when developing alternate pedestrian routes. It then moves on to address the actual physical requirements for accessible paths through work zones.

## Approaches to Routing Pedestrians

Addressing pedestrian accessibility in a temporary traffic control area can be distilled down into three approaches. These include:

- Maintaining the existing pedestrian pathways if the sidewalks can remain open during construction.
- Developing an alternative pedestrian pathway that is parallel to or easily reached from the current pathway if the current pathway must be closed. For example, using concrete or other crashworthy barriers for protection, pedestrians can be detoured into a channelized pathway on a road adjacent to the work area (see figure 1).

- If the existing pedestrian path must be closed, identifying and developing an alternative pedestrian pathway in advance of the TTC that will detour pedestrians around the TTC (for example, if the sidewalk on the same side of the street as the construction must be closed and a parallel pathway is not feasible, then pedestrians can be re-routed across the street to a parallel sidewalk).

The first and most important consideration for all pedestrians is safety. Pedestrians must be kept in a safe environment, ideally on a smooth, well-marked travel path. The following are general considerations to take into account when assessing the best approach to use for pedestrian accommodation and accessibility.

Keep in mind that the concept of what a safe, useful pedestrian pathway is has evolved to incorporate many ADA elements, so addressing the needs of the disabled is an inherent element in well-planned and properly engineered pedestrian facilities.

### Maintaining Accessibility on the Current Pathway

If it is determined that the current pedestrian facility can remain safely open to all users during construction, the MUTCD clearly states that temporary facilities must include accessibility features consistent with the features present in the existing pedestrian facility. For example, if the current facility features accessible curb ramps with detectable warning surfaces, then the TTC facility must provide the equivalent elements.

### Creating an Accessible Alternate Pathway: General Considerations

In the event that an alternative pathway must be created to accommodate pedestrians, engineers need to consider a number of factors. One factor is the general environment: are there pedestrian generators such as schools, shopping areas, community or senior centers, transit facilities, etc. in close proximity to the traffic control zone? Are pedestrians present at all? A second factor is the characteristics of the traffic that frequents the area, such as speed, volume, the significant presence of commercial vehicles traversing the area, etc.



**Figure 2. Where Feasible, Same-Side Travel is the Preferred Option**

According to Section R205 of the PROWAG, and reinforced by Part 6D.01 of the MUTCD, where feasible, same-side travel is the preferred option because it does not increase pedestrian exposure to traffic and the attendant risk of accident that an added street crossing brings. Note that, depending on the characteristics of the traffic and the surrounding environment, a route that uses a vehicle lane width for the pedestrian pathway may be shorter, safer, and more usable than one that requires two street crossings, even if the roadway surface is imperfect.

It's also important to remember that pedestrians are not likely to back-track – meaning that they need early warning of what they are approaching, as they may be more inclined to go into the street to avoid a short closure rather than retrace their steps back to a designated crosswalk.



**Figure 1. Example of a Parallel Pedestrian Pathway**

*The concept of what a safe, useful pedestrian pathway is has evolved to incorporate many ADA elements, so addressing the needs of the disabled is an inherent element in well-planned and properly engineered pedestrian facilities.*

In areas that are rural, or where few or no pedestrians exist, the need for temporary facilities will depend on several factors, including whether there is an existing sidewalk. Per ADA and MUTCD requirements, any alternative pedestrian pathway must have at least the same level of accessibility as the one it is replacing, so if a paved walkway is present, an alternative walkway featuring a smooth, continuous, hard surface should be provided throughout the entire length of the temporary facility. There should be no curbs or abrupt changes in grade or terrain that could cause tripping or be a barrier to wheelchair use. If there is no sidewalk, however, no wide shoulder on which pedestrians are permitted to walk, or no evidence of existing pedestrian activity (i.e. worn dirt paths, visual observation of people walking in roadway, adjacent bus stops, adjacent pedestrian destinations such as schools or shopping centers, etc.), the project may not require an accessible alternative pedestrian route.

Pedestrian considerations should be treated as a facet of a TCP. Pedestrian treatments can be addressed as a subsection of the overall plan, identifying and addressing relevant factors and considerations unique to the work zone (see section on Best Practices).

### **Speed**

If the work zone will be in an area where the speed is 35 mph or less, it is advisable to maintain longitudinal separation with channelization devices, curbing, railings, or barricades at a minimum. If the TTC will be in an area of high crash frequency or if there is concern over pedestrian exposure and risk, the use of positive protection should be considered.

If the work zone will be in an area where the speed is 40 mph or more, provide positive protection with crash cushions or barriers, or consider detouring pedestrians across the street or around the block to open, permanent pedestrian facilities, as appropriate.

Be sure to establish temporary pedestrian facilities that are completely separated from work vehicles, equipment, operations, and vehicles moving through or around the worksite.

### **Access to Businesses and Transit**

Note that, in addition to the pedestrian path in general, access to business entrances and transit stops will need to be maintained. This may require construction of temporary ramps and guide rails from the pedestrian pathway to the entrances of buildings or businesses. If the pedestrian facility currently has a transit stop that will be affected by the work zone, practitioners should consult the transit authorities that service the affected stop to determine whether a temporary stop will need to be created either inside the traffic control area or external to it. If the construction zone is extensive and will impact multiple stops, it may be necessary to arrange for a shuttle or establish a temporary route that transports pedestrians safely around the work area. Any changes to transit stop locations or schedules due to construction must be provided in an accessible format, preferably well in advance of the TTC, but also via other information outlets addressed in the next section.



**Figure 3. Access to Businesses and Transit will Need To Be Maintained.**

If an alternative pedestrian pathway is going to be created that requires pedestrians to cross multi-lane intersections, pedestrian walk phase timing may need to be adjusted to accommodate the presence of the disabled. Note that when designing for pedestrians, the 2009 MUTCD recommends 3.5 ft./sec. This is consistent with recommendations developed by the Access Board to ensure that persons with physical impairments have enough time to cross a street.

## Communicating with the Public

Many of the challenges encountered by visually impaired pedestrians are information-related and can be addressed in two ways: by improved communication at the site of the work zone and by improved communication with the public that also targets disabled transportation system users in general.

Broadly speaking, Title II requires that the State or local agency performing the work ensure that communications with individuals with disabilities are as effective as communications with others. In general, standard public announcements via public service messages, the Internet, radio and TV, area newspapers, phone messaging, etc. should be made to advise the community of the location and duration of temporary traffic control for significant reconstruction projects that will have long-term impacts on pedestrians. These announcements should include information targeted to disabled persons needing to access pedestrian facilities or should provide contact information where specialized information can be obtained, such as a special telephone and TTY lines. In addition, the agency must provide appropriate auxiliary aids and services for people with disabilities onsite at the temporary traffic control area (see the section below on Physical Characteristics of the Temporary Traffic Control Zone for a more detailed discussion of this targeted communication).

## Physical Characteristics of an Accessible Temporary Facility

The devices and features that are required to provide an accessible alternate pedestrian pathway are similar to those required to guide traffic through a TTC zone. As with drivers, pedestrians, too, must be warned in advance of changed conditions and advised of their options for alternate routes. When they approach the work area, disabled pedestrians need guidance on any changes from the normal route, such as shifts in the walkway alignment, in the same way that drivers must be warned about lane changes. As with vehicles, when pedestrians traverse the work zone, the route must be clearly marked, be provided with a suitable surface, and they must be protected from other traffic and work operations, including drop-offs. When they exit the work area, pedestrians need to be guided back to their original route.

There are a number of specific guidelines for the physical characteristics of an accessible pedestrian pathway that are outlined by the MUTCD, ADAAG, and PROWAG. As discussed previously, MUTCD's standards represent requirements, as do those of ADAAG, and while PROWAG's guidance is only advisory, so its recommendations should be considered best practices and adopted where feasible when creating a temporary pedestrian pathway. These guidelines, as well as the standards set forward in the MUTCD, are summarized below.

### Communication Devices

One of the most important factors to consider when planning a work zone is how to communicate with the disabled pedestrians who are approaching and will be using the pedestrian pathway about where the work zone is located and how to navigate it safely.

The MUTCD notes that the "most desirable way" to provide guidance through TTCs for people with visual disabilities is "a speech message provided by an audible information device...[which] is needed when the detectable barricade or barrier for an alternate channelized route is not continuous." The best devices are those that provide "speech messages in response to passive pedestrian actuation," although devices that

#### **PROWAG Advisory R302.1**

*Temporary routes are alterations to an existing developed pedestrian environment and are required to achieve the maximum accessibility feasible under existing conditions.*



continuously emit a message or emit a message in response to use of a pushbutton are also acceptable. A pushbutton used to provide equivalent TTC information to pedestrians with visual disabilities should be equipped with a locator tone to notify the vision impaired that an accessible message is available and to help them locate the pushbutton.

The MUTCD also advises that audible information “might not be needed if detectable channelizing devices make an alternate route of travel evident to pedestrians with visual disabilities.”

Note that, while it is now possible for guidance and warning information to be transmitted to personal receivers, these devices may not be carried by pedestrians with visual disabilities; this method should not be wholly relied upon to convey important information.

The audible messages provided should clearly state instructions on accessing the detour route, such as “Attention pedestrians, sidewalk closed 1 block ahead, cross here to use other side of street” or “Attention westbound Maple Street pedestrians. Sidewalk construction ahead. Ramp slopes down. Temporary fenced path in street is open. Rejoins original sidewalk after 100 feet.” Other important pieces of information include turning or crossing instructions, the location of temporary transit stops or transit stop closures, and the route to alternate transit stops.



**Figure 4. Audible Information Device in Advance of a Closed Sidewalk**

**Table 2. Minnesota DOT Guidance for Audio Message Device Features**

<b>Activation:</b>	Various categories may be developed, such as motion sensitive, push-button, and continuous.
<b>Color:</b>	Should contrast with “typical” surrounding background. This is highly recommended if the pedestrian is required to find a pushbutton to activate the audible message.
<b>Weather Proof:</b>	The device should be weather proof for typical Minnesota weather conditions, including extremes in temperature, moisture and wind.
<b>Power Source:</b>	Various power source categories may be developed, including replaceable batteries, solar-charging batteries, external power feeds, or other alternatives.
<b>Message Length:</b>	The device <b>shall</b> provide adequate recording length for clear informational message needs. The minimum time will be determined, but assume 30 seconds min.
<b>Mounting:</b>	The device should be capable of being mounted on a standard TTC channelizing device or be integral with its own deployment system.
<b>Security:</b>	The device should be designed with theft and vandalism deterrents.
<b>Volume Control:</b>	The device <b>shall</b> playback the recorded message at a level that readily overcomes typical ambient sound levels such as traffic, construction and crowd noise. Volume control categories may be developed such as automatic volume control (dependent on ambient levels) and manually adjusted volume control. Note that APS systems require 5 decibels over ambient, which may also be the final spec for AMDs.

Source: Minnesota Department of Transportation, “PROWAG/ADAAG Standards Guidance For Temporary Pedestrian Access Route (TPAR) Facilities and Devices – Draft,” May 11, 2010.

Information may also be provided in a Braille format and formats with raised lettering/maps for those who rely on their tactile capabilities for information.

It is also important to keep in mind that people with cognitive disabilities have different processing and decision-making skills, and that their language comprehension skills may be limited. As

a result, signing and visual messages to accommodate people with disabilities should be clear and concise, with large, clear lettering, high contrast, and easy to understand symbols.

*Signing and visual messages to accommodate people with disabilities should be clear and concise, with large, clear lettering, high contrast, and easy to understand symbols.*



Proper signage warning of the upcoming TTC should be placed well in advance to allow disabled pedestrians to select an alternate route if they are not comfortable navigating the TTC. Sign placement should be in advance of the construction site at beginning of the block at an accessible crossing point. Similar to audio messages, signage should include any specialized instructions that may be informative to a disabled person (e.g., the presence of ramps, where the temporary traffic control area will terminate, whether alternative access routes to businesses or destinations are available, the availability of busing to transport pedestrians around the TTC, etc.)

In addition, a guide can be provided in advance of the temporary traffic control area to assist any disabled or impaired persons in navigating the accessible pathway. This may be particularly appropriate in areas where there are known to be higher concentrations of individuals with disabilities. The presence of a large number of disabled persons would be determined during the planning phase, while engineers are assessing the general environment for pedestrian generators and other factors that may call for special access accommodations prior to designing a TCP.

## Overhead and Protrusion Protection

In the event that the accessible pedestrian route uses a canopied walkway to protect pedestrians from falling debris, the MUTCD states that such a walkway should have a minimum of 7 ft. (84 inches) of headroom, although the PROWAG advises 80 inches. Objects with leading edges more than 27 inches and not more than 80 inches above the walk (such as signs) are not permitted to protrude more than 4 inches into the pedestrian pathway. Other elements of the vertical environment that affect accessibility are discussed below.

## Channelizing Devices

Consider erecting barriers as positive protection for pedestrians when they might otherwise be exposed to traffic. This may include concrete, steel, or water-filled barriers. The pedestrian channelizing devices should be used both to close sidewalks and to delineate an alternate route. When used properly, they should indicate a suitable path of pedestrian travel around or through the TTC, and the bottom and top surfaces of the pedestrian channelizing device should have retroreflective material or delineation for improved nighttime visibility.

Note that the MUTCD prohibits the use of tape, rope, or plastic chain strung between devices because they are not detectable and do not comply with the design standards in the ADAAG; therefore, they may not be used as a control for pedestrian movements (MUTCD 6D.01). Joints between channelizing devices should be closed and flush to prevent canes or small wheels from being trapped, to reduce the risk of tripping, and to facilitate safe hand trailing. Furthermore, when used as a sidewalk closure mechanism, channelizing devices must run the entire width of

### **MUTCD Section 6D.02:**

*Where pedestrians with visual disabilities normally use [a] closed sidewalk, a barrier that is detectable by a person with a visual disability traveling with the aid of a long cane shall be placed across the full width of the closed sidewalk.*

the sidewalk without gaps; gaps in coverage could lead to visually disabled persons accidentally crossing into the work space, where they may be exposed to trips, falls, and severe injuries.

According to MUTCD guidance, pedestrian channelizing devices should be vertical, sturdy, and have smooth, continuous surfaces that are free of sharp or rough edges or objects which may harm hands, arms, or clothing (MUTCD 6F.63). Devices used to channelize pedestrians must be detectable to users of long canes and visible to persons having low vision, so, per the MUTCD, the lower edge of the bottom portion of the devices used must be no more than 2 inches above the walkway. ADAAG advises (and MUTCD supports) that no part of the device used may extend more than 4 inches into the pedestrian pathway because they can cause a wheelchair or motorized cart to get stuck or overturn, may trip a visually disabled person, or may cause someone using a cane to become disoriented.

Per the MUTCD (6F.63), where channelizing devices are used to channelize pedestrians, the top of the top surface must be no lower than 32 inches above the walkway. The top surface should be smooth, and both upper and lower surfaces should have a common vertical plane. Furthermore, the devices should be continuous and parallel with the walkway surface and be supported in such a way that there is minimal interference to the pedestrian's hands or fingers. Be aware that while the guidance on surfaces and planes is currently a best practice, the NCUTCD has proposed language that would change this recommendation to a requirement (see box).

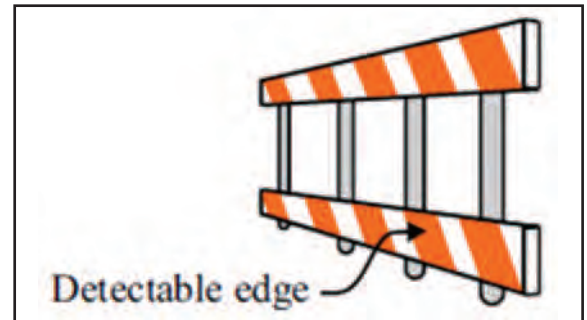

**Figure 5. Example of a Pedestrian Channelizing Device with a Detectable Edge**

***Proposed NCUTCD Standard for New MUTCD Language on Channelizing Devices:***

*Pedestrian channelizing devices shall have continuous bottom and top surfaces. The lower edge of the bottom portion shall be no higher than 2 inches above the walkway. The top edge of the bottom portion shall measure at least 8 inches above the walkway. The top of the top portion shall be no lower than 32 inches above the walkway. The top surface shall be smooth to optimize hand-trailing. Both upper and lower surfaces shall share a common vertical plane.*

Color contrast is important for pedestrians with low vision, and should be taken into account when selecting channelizing devices. Orange is a good color to use as it is seen as the “standard” color for construction, provides color contrast, and seldom results in glare. Do not use black to color any base on a device as the black can blend in with the pathway surface, which could cause a tripping hazard.

Per MUTCD 6F.63, when exposed to vehicular traffic, channelizing devices should be able to provide positive protection to pedestrians, and the bottom and top surfaces of devices must have retroreflective material or delineation on the side exposed to traffic for improved nighttime visibility. On those surfaces facing the

pedestrians, the devices should have a contrasting pattern in alternating light and dark colors to provide visual contrast on the upper surface that consists of a minimum of 6 inches of sheeting or other contrasting materials. Non-retro reflective materials may be used on the pedestrian-facing side of the channelizing device.

***Proposed NCUTCD Standard for New MUTCD Language on Channelizing Devices:***

*Pedestrian channelizing devices shall be crashworthy when exposed to vehicular traffic.*

The following listing describes the various types of pedestrian channelizing devices and who may benefit.

- **Detectable Edging provides the channelizing for long-cane users.** Detectable edging used alone will provide guidance to sighted pedestrians, and visually impaired pedestrians (if high contrast colors are utilized), but may introduce a tripping hazard and has limited effect for preventing non-disabled pedestrians from leaving the route. Detectable Edging specifications are listed above.
- **TTC Barricades provide visual channelizing to both non-disabled and visually impaired pedestrians** (if high contrast colors are utilized). See the MUTCD for Specifications on Type I, II or III Barricades. NOTE: Typical TYPE III Barricades may provide adequate visual guidance, but the standard legs would present a tripping hazard and would not provide any guidance for long-cane users. Keep in mind that:
  - a. Barricade rail supports may not project into pedestrian circulation routes more than 4 inches from the support between 27 and 80 inches from the surface as described in ADAAG Section 4.4.1 and
  - b. Barricades should be crashworthy [if] they are located adjacent to vehicular traffic flow and are subject to impact by errant vehicles, per MUTCD 6F.63.
- **Longitudinal Channelizers provide visual channelizing to those pedestrians who are non-disabled, who are visually impaired (if high contrast colors are utilized), and who use a long-cane (if a detectable edge is incorporated into the channelizer design).** Longitudinal channelizers may also provide a suitable mounting surface for a handrail or guiderail.
- **Handrails (if high contrast colors are utilized) provide channelizing guidance to all pedestrians through vision and tactile.**
- **Guiderails (if high contrast colors are utilized) provide channelizing guidance to all pedestrians through vision and tactile.**
- **Temporary Traffic Barriers** provide channelizing benefits similar to Longitudinal Channelizers, but they must be manufactured and installed such that gaps are within specifications for detectable edging and adequate contrasting colors are provided.
- **Pavement Markings (e.g., crosswalk markings) provide visual channelizing to the non-disabled and visually impaired (if high contrast colors are utilized).** Painted markings have no benefit for long-cane users.

## Handrails and Guiderails

It is important to make a distinction between handrails and guiderails because they serve different purposes and their characteristics are governed by different standards. Handrails are required to assist ambulatory disabled pedestrians navigate steep grades along walkways as per the standards listed below. Guiderails are NOT intended to provide the required support as specified for handrails; rather, they provide visual and tactile guidance to all pedestrians along a designated route.

### Handrail Requirements

Per ADAAG section 4.8.5, ramps used on pedestrian access routes that have a rise greater than 6 inches or length greater than 72 inches should have handrails on both sides. Handrails should be mounted 34 to 38 inches above the walkway surface (to top of rail), maintain a minimum of 36 inches between the handrails, and should have a minimum clearance of 1.5 inches behind and 18 inches above. The front face of the handrail should be aligned within +/- 4 inches of the detectable edge face.

Be sure that handrails have a width between 1.25 and 1.5 inches and contain a “graspable” cross-section. Edges must have a minimum radius of 1/8 inch. Handrails are prohibited from being able to rotate within their fittings, and must be free of any sharp or abrasive elements. They should have a continuous gripping surface, but when they are not continuous, they should extend a minimum of 12 inches beyond the end of ramps. On switchback or dogleg ramps, the inside handrail must be continuous. Furthermore, handrails should be parallel with the walkway surface and either have rounded ends or turn towards the ground, wall, or post.

Per ADAAG 4.26.3, the structural strength of handrails, fasteners, and mounting devices are required to meet the following specification:

- Bending stress in a handrail induced by the maximum bending moment from the application of 250 pound force shall be less than the allowable stress for the material of the handrail.
- Shear stress induced in a handrail by the application of 250 pound force shall be less than the allowable shear stress for the handrail. If the connection between the handrail and its mounting bracket or other support is considered to be fully restrained, then direct and torsional shear stresses shall be totaled for the combined shear stress, which shall not exceed the allowable shear stress.
- Shear force induced in a fastener or mounting device from the application of 250 pound force shall be less than the allowable lateral load of either the fastener or mounting device or the supporting structure, whichever is the smaller allowable load.

## Guiderails

As mentioned above, guiderails are distinct from handrails in that they provide visual and tactile guidance to pedestrians along a designated route, but they do not provide the sturdiness or support features of a handrail. Therefore, it is very important that users of the pedestrian pathway be able to distinguish between a guiderail and a handrail so that they are aware that the guiderail is not a weight-bearing device, but is capable only of providing tangible guidance along the route. This can be accomplished by allowing the guiderail to be semi-flexible, have a non-rigid mounting or be an “ungraspable” shape.

In general, guiderails do not meet accessibility standards without the addition of approved detectable edging. It is recommended that the use of guiderails be limited to those pedestrian routes that call for special guidance through turns, curves, or crowd directional control.

Guiderails should have a top surface width of a minimum of 0.5” (contrast this to the 1.25” minimum required for handrails) to allow the hand to feel the surface. As mentioned previously, the surface should be smooth and free of any sharp or abrasive elements to facilitate hand trailing.

Guiderails should be mounted at the same height as handrails with the same clearance considerations and should generally be parallel with the walkway surface. When a guiderail is used to guide pedestrians along an accessible route, the guiderail surface should be continuous for length of pathway, although it may be interrupted by posts or short gaps. The length of gap should not permit pedestrians to maneuver through the gap, however.

## Surfaces

The ADAAG advises that joints should be closed and flush to prevent tripping and to reduce the possibility of canes or small wheels getting trapped in gaps or spaces. If drainage openings are located within the pedestrian route, then the grating should run perpendicular to the pathway and must be narrow enough that a sphere greater than ½ inch in diameter will not pass through it.

Pathways should be clear of debris and adequately drained to prevent accumulation of trash or mud that can cause a tripping or slipping hazard. Furthermore, a minimum, continuous, clear width of 48 inches, free of obstructions, should be maintained, although a width of 60 inches is recommended, where feasible. Also, be advised that where the clear width of pedestrian access routes is less than 60 inches, passing spaces must be provided at intervals of a maximum of 200 feet. Passing spaces must be a minimum of 5 feet by 5 feet.

The surface of the pathway should be as clear and as flat as possible. It is important to keep in mind that some mobility-impaired pedestrians are not able to navigate steps or uneven surfaces without becoming disoriented or losing their balance. Furthermore, per the MUTCD guidance, a continuously detectable edging that can be

followed by pedestrians using long canes should be provided throughout the length of the facility. This edging should protrude at least 6 inches above the surface of the sidewalk or pathway, with the bottom of the edging being a maximum of 2.5 inches above the surface. Detectable pedestrian edging should be orange, white, or yellow and should match the color of the adjacent channelizing or traffic control devices, when present.

## Temporary Curb Ramps

When pedestrian are diverted to temporary routes in the roadway, temporary curb ramps should be provided to enable them to negotiate curbs safely. Temporary curb ramps should be the full width of the temporary route, with a 60-inch recommended width and a minimum width of 48 inches. As noted in the section handrails, handrails on curb ramps are not required unless the curb ramp has a rise exceeding 6 inches rise and a length exceeding 72 inches. Ramps should generally lie in a single sloped plane with a minimum of surface warping. The ADAAG advises that curb ramps will ideally have a slope of 1:12 or less, but where space limitations prohibit this, a slope between 1:10 and 1:12 is allowed for a maximum rise of 6 inches and a slope between 1:8 and 1:10 is allowed for a maximum rise of 3 inches. A slope steeper than 1:8 is not allowed.



**Figure 6. All Ramps Should be Firm, Stable, and Have a Non-Slip Surface**

All ramps should be firm, stable, and have a non-slip surface. They should not warp or buckle, and should be made of materials strong enough to support the weight of pedestrians as well as motorized scooters and wheelchairs. Ramps should also be color contrasting and contain marked edges so they are noticeable by pedestrians who have visual impairments. Furthermore, ramps should also have free draining surfaces with a maximum cross slope of 2 percent. Note that the cross slope for midblock crosswalks can match the running slope of the roadway up to a maximum of 5 percent.

When placing temporary curb ramps, workers should avoid placing ramps near drainage collection areas because ponding or running water could cause slippery or unstable conditions for individuals who use crutches or walkers.

## Transitions

Transitions from ramps to walks, gutters, or streets should be flush and free of abrupt changes, and while vertical changes up to 1/4 in do not require edge treatment, although ADAAG (Section 4.5.2) advises that changes in level between 1/4 in and 1/2 in (6 mm and 13 mm) will need to be beveled and have a slope no greater than 1:2. Maximum slopes of adjoining gutters, road surface immediately adjacent to the curb ramp, or the accessible route may not exceed 1:20. Per ADAAG (Sections 4.7 and 4.8), ramp slopes may be 1:8 with a maximum rise of 30 inches for any run. As mentioned previously, if a ramp run has a rise greater than 6 in or a horizontal projection greater than 72 in, then it must have handrails on both sides (ADAAG 4.8.4 and 4.8.5).

### **ADAAG Section 4.3.8:**

*If an accessible route has changes in level greater than 1/2 in, then a curb ramp, ramp, elevator, or platform lift shall be provided. An accessible route does not include stairs, steps, or escalators*

Finally, PROWAG R304.2.1 advises that when a ramp is installed parallel to the curb, a 48 inch by 48 inch platform should be provided at curb level to allow pedestrians to turn 90 degrees before descending the ramp.

## Lighting

Good lighting is important to pedestrians as it provides a sense of personal security, safety, and enables them to see signs and instructions clearly. Many visually impaired pedestrians testify to the importance of good lighting conditions. Lighting should illuminate the route, any obstructions, changes in elevation, and changes in surface texture. When planning a pedestrian pathway as part of a TCP, consideration should be given to avoiding trees and other objects that would cast a shadow and obstruct the light output.

# Best Practices for Work Zone Design and Planning

In 2010, The Minnesota Department of Transportation (MnDOT), manufacturers and persons with disabilities came together to hold a Temporary Pedestrian Route Workshop and Demonstration. The event was a joint effort planned and developed by MnDOT, the American Traffic Safety Service Association, and experts from the manufacturing side. One result of this workshop was a set of suggestions from the disabled community and the other attendees as to how to maximize the accessibility of temporary pedestrian access routes. The following questions and responses can be used by practitioners who are tasked with developing a response to the more specific and far-reaching ADA requirements that will likely be adopted nationwide in the near future.

## 1. What should agencies do to let designers and contractors know about the placement of signs, vehicles, equipment and materials such that they do not impede access to, or use of sidewalks, pedestrian ramps, and other pedestrian route infrastructure?

- *Provide a separate certification course for accessibility evaluators, until accessibility standards are totally incorporated into standard practice.*
- *Consider making a statement of policy that “no vehicles, equipment or materials shall block sidewalks, pedestrian ramps or other pedestrian infrastructure without approval of the engineer.”*
- *Include accessibility requirements in special provisions, field manual, and permit forms to make them enforceable.*
- *Train inspectors and project engineers to enforce pedestrian access route restrictions.*
- *Place messages on plans and other bid documents to raise awareness of challenges posed by construction projects impacting pedestrian access routes.*
- *Include accessible route plans for large, pedestrian-impacted projects that include messages on maintenance of active pedestrian access routes during the project.*
- *Solicit input from local pedestrians including people with disabilities on types of devices and how they will be placed and used, and lengths and times of any closures.*
- *Consider movement of vehicles and equipment across pedestrian routes, appropriate storage and lay down areas, proper drainage near pedestrian routes, access to accessible features such as push buttons and bus stops, and proper placement of materials and equipment to maintain visibility between pedestrians and motorists/construction workers.*
- *Provide work zone refresher training to construction personnel emphasizing accessible pedestrian paths.*
- *Provide design and device training to traffic staff as agency guidelines and standards begin to be developed.*
- *Acknowledge that some impacts cannot be avoided and that those impacts apply to residents, businesses, motorists and pedestrians alike. However, good planning can minimize their duration and extent.*

## **2. How do work zone planners determine if pedestrians should be routed through a construction area or around it (i.e., how do we calculate or determine undue hardship for persons in the disabled community)?**

- *Solicit input from local pedestrians including people with disabilities.*
- *Consider the nature of the work in the determining whether to set up a detour. Large, dangerous excavations are more likely to require a detour versus smaller utility repairs that may be easier to route through.*
- *Prioritize routing through if it is safe to do so – consider narrowing the route or placing the route in the street, and determine that the contractor will not need to cross the route frequently.*
- *Put yourself in the pedestrian’s shoes and think about whether YOU would take a particular detour:*
  - *Is the route confusing?*
  - *Can the detour be clearly communicated?*
  - *Is the detour accessible?*
  - *Does the detour cut off access to bus stops?*
  - *Does the detour require crossing heavy traffic volumes or wide intersection approaches?*
- *Solicit trainers and people with disabilities to evaluate prospective detour routes and develop a list of concerns about issues that may cause undue hardship. This list might be subcategorized based on type of disability.*
- *If a safe and accessible route cannot be maintained through or around construction, then other options should be explored, such as shuttle service.*
- *Consider distance, quality of terrain, pedestrian volumes, vehicle volumes, and required construction durations.*

## **3. Which devices or installation schemes would best qualify for development of standard plates or standard plans?**

- *Contractor curb ramp*
- *Handi-Ramp curb ramp*
  - *Consider various curb ramp sizes to accommodate curb heights taller than 6”.*
- *Clear area protection*
- *Consider creating an approved list of ADA compliant products that designers and planners can select from when designing a work zone.*

## **4. Do you have any suggested best practice for methods of depicting accessible devices or installations within a plan set or on Traffic Control Plan sheets?**

- *Suggest using standard symbols for items such as audible devices, pedestrian longitudinal channelizing devices, etc.*
- *Recommend a separate Temporary Pedestrian Access Plan that will indicate placement of various elements and could also include additional notes and information, such as the audible messages to be broadcast at the various audible message device sites, time restrictions for building access, etc.*
- *Suggest indicating accessible routes on the Traffic Control Plan sheets. The accessible route could be indicated via a line style that is also depicted on the Traffic Control Plan legend. The accessible route lines on the plan could be noted “See TPAR Plans.”*



# Conclusions

While accommodating all pedestrians in work zones can be challenging, it is not impossible. Guidance documents are being developed by Federal agencies to encourage compliance with relevant legislation and requirements.

Likewise many agencies are beginning to develop policies and guidance on pedestrian accessibility in work zones, effectively advancing the state of the practice in accessible work zone design and installation (see appendices for examples of existing State-level guidance). Proprietary traffic control device manufacturers continue to research needs and develop a range of products to accommodate pedestrians with all types of disabilities. Agencies should use these collective resources to develop and implement policies and practices to consistently meet the needs of all pedestrians through work zones.

## ***PROWAG, R205 Alternate Pedestrian Access Route:***

*When an existing pedestrian access route is blocked by construction, alteration, maintenance, or other temporary conditions, an alternate pedestrian access route complying to the maximum extent feasible with R301 [Pedestrian Access Route requirements], R302 [Alternate Circulation Path requirements], and Section 6D.01 and 6D.02 of the MUTCD... shall be provided.*

# Appendix A. National Committee on Uniform Traffic Control Devices (NCUTCD) Proposed MUTCD Language

The Temporary Traffic Control Committee of the National Committee on Uniform Traffic Control Devices (NCUTCD) proposed Language to add to the MUTCD. The proposed language was approved by the NCUTCD on June 23, 2011, for new section on Pedestrian Channelizing Devices. It is as follows:

## **Section 6F.xx Pedestrian Channelizing Devices** [suggest placing after Section 6F.63 Channelizing Devices]

### **Support:**

Pedestrian channelizing devices indicate a suitable path of pedestrian travel around or through the work zone.

### **Guidance:**

*Pedestrian channelizing devices should be provided when work activities impact sidewalks and/or other pedestrian facilities or when the design of the temporary pedestrian facility does not otherwise include accessibility features consistent with the features in the existing pedestrian facility.–*

*The pedestrian channelizing devices should be used both to close sidewalks and to delineate an alternate route.*

### **Support:**

An example of a Pedestrian Channelizing Device is depicted in Figure 6F.xx.

### **Standard:**

**Pedestrian channelizing devices shall be crashworthy when exposed to vehicular traffic.**

**Devices used to channelize pedestrians shall be detectable to users of long canes and visible to persons having low vision.**

**When used as a sidewalk closure, the device shall cover the entire width of the sidewalk.**

### **Standard:**

**Pedestrian channelizing devices shall have continuous bottom and top surfaces. The lower edge of the bottom portion shall be no higher than 2 inches above the walkway. The top edge of the bottom portion shall measure at least 8 inches above the walkway. The top of the top portion shall be no lower than 32 inches above the walkway. The top surface shall be smooth to optimize hand-trailing. Both upper and lower surfaces shall share a common vertical plane.**

### **Option:**

A continuous wall may be used as a pedestrian channelizing device.

### **Guidance:**

*When used, a continuous wall should have a lower edge no more than 2 inches above the walkway, should extend a minimum of 32 inches above the walkway, should have a common vertical face and should have alternating, contrasting sheeting positioned 32 inches above the walkway.*

### **Option**

The continuous wall may extend to any height above the 32 inch minimum.

### **Guidance:**

*When pedestrian channelizing devices are combined in a series, the gap between devices should not exceed one inch.*

**Support:**

A Hand-Trailing Edge is the upper surface of the upper rail on a pedestrian channelizing device, as shown in Figure xx. It is provided to allow pedestrians with limited vision to follow the pedestrian channelizing device with their hand. The Hand-Trailing Edge is not a weight bearing railing.

Attachment No. 5b

### Figure 6F-XX Pedestrian Channelizing Device

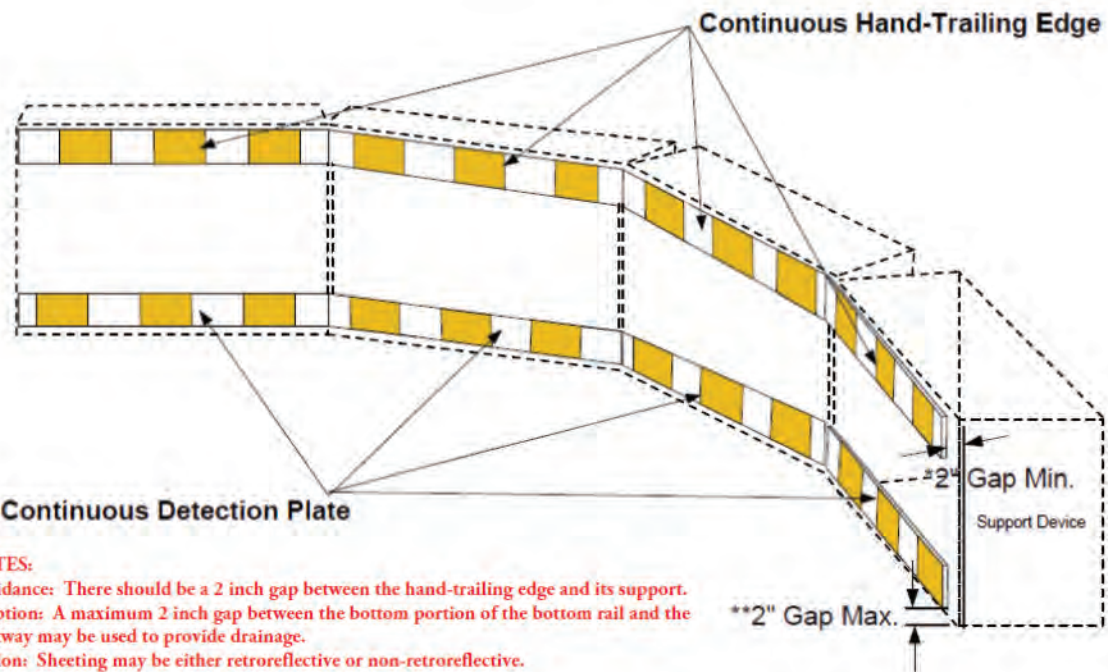
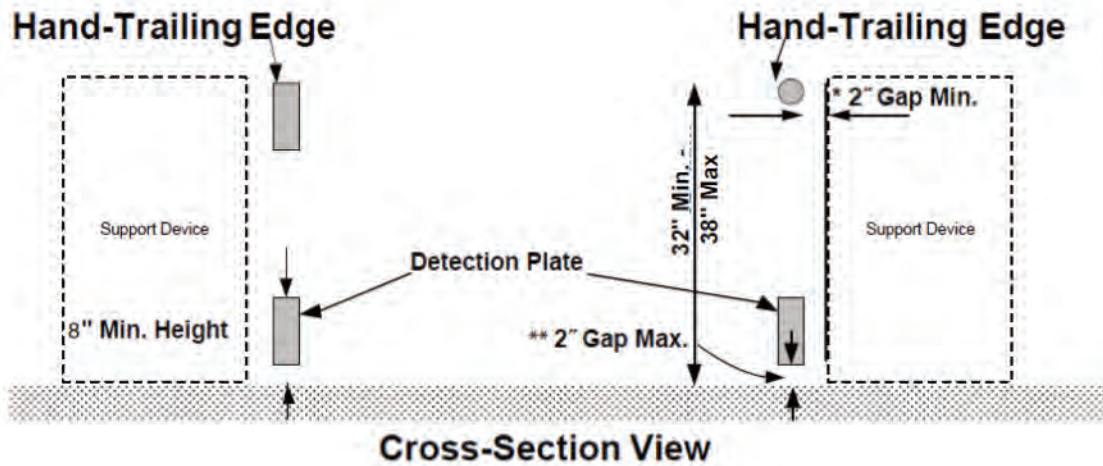

- NOTES:**
- \*Guidance: There should be a 2 inch gap between the hand-trailing edge and its support.
  - \*\*Option: A maximum 2 inch gap between the bottom portion of the bottom rail and the walkway may be used to provide drainage.
  - Option: Sheeting may be either retroreflective or non-retroreflective.
  - Option: Sheeting panels may be either vertical or at a 45 degree angle.
  - Option: Hand-Trailing Edges and/or Detection Plates are optional for continuous walls.

Figure 7. NCUTD Proposed Guidelines for Pedestrian Channelizing Devices

**Standard:**

When exposed to vehicular traffic the bottom and top surfaces of the Pedestrian Channelizing Device shall have sheeting complying with Section 6F.71 line 03.

**Guidance:**

*When not exposed to vehicular traffic, the Pedestrian Channelizing device should have a contrasting pattern in alternating light and dark colors to provide visual contrast on the upper surface consisting of a minimum of 6 inches of sheeting or other contrasting materials. Non-retroreflective materials may be used on the pedestrian side of the Pedestrian Channelizing device.*

**Option:**

The sheeting on the side of the device on the pedestrian side of the Pedestrian Channelizing device may have sheeting with a vertical orientation.

**Support:**

The contrast of the light and dark stripes on the barricade sheeting assists low-vision pedestrians in following the designated detour.

# Appendix B. Minnesota Department of Transportation Standards, Drawings, and Sample Specification

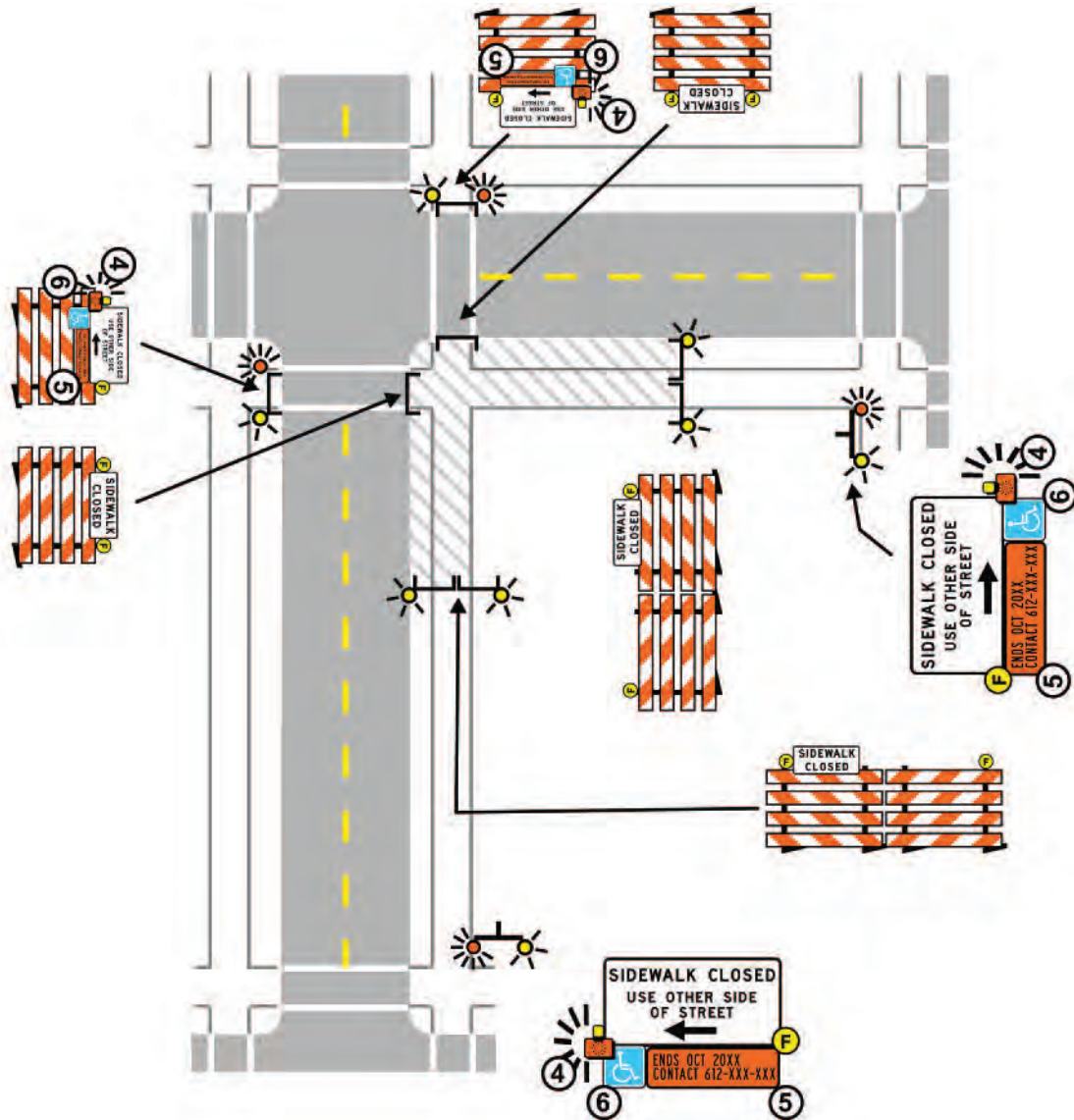

A flasher mounted on the sign or barricade shall be used on all nighttime sidewalk closures.

Figure 8. Layout 84B: Crosswalk Closures and Pedestrian Detours

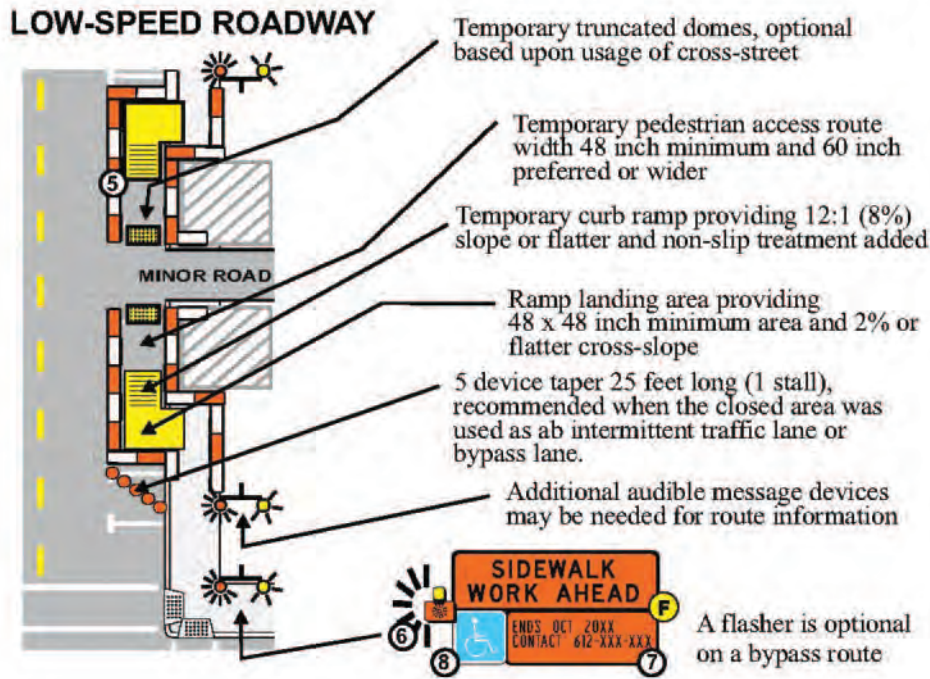

Figure 9. Minnesota DOT Drawing 85a: Sidewalk By-Pass on a Low Speed Roadway

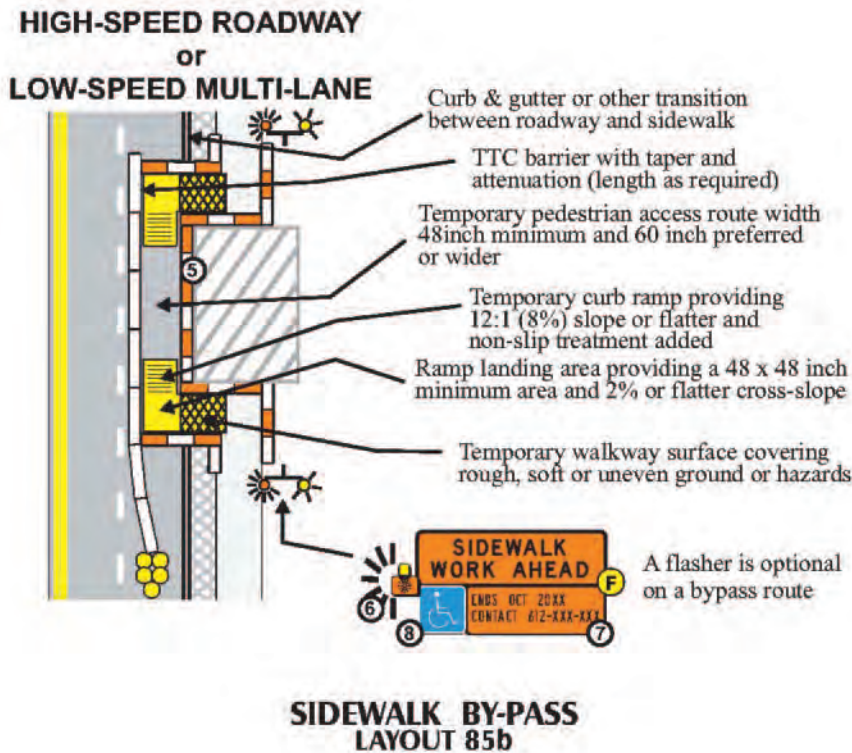

Figure 10. Minnesota DOT Drawing 85b: Sidewalk By-Pass on a High Speed Roadway or Low-Speed Multi-Lane Road

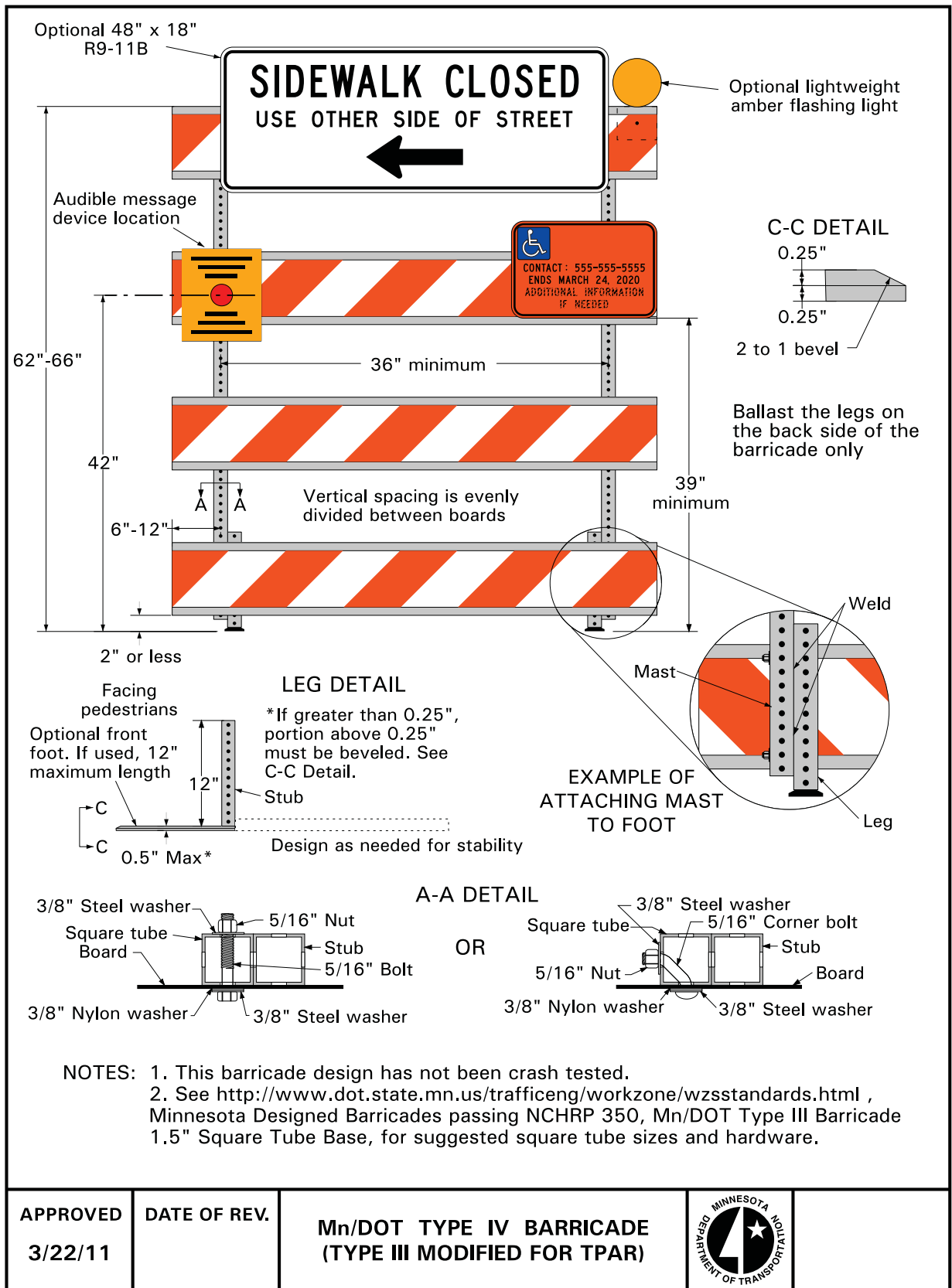
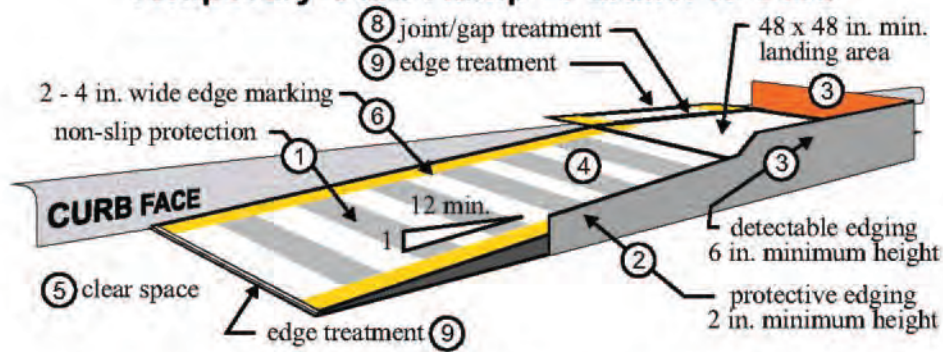
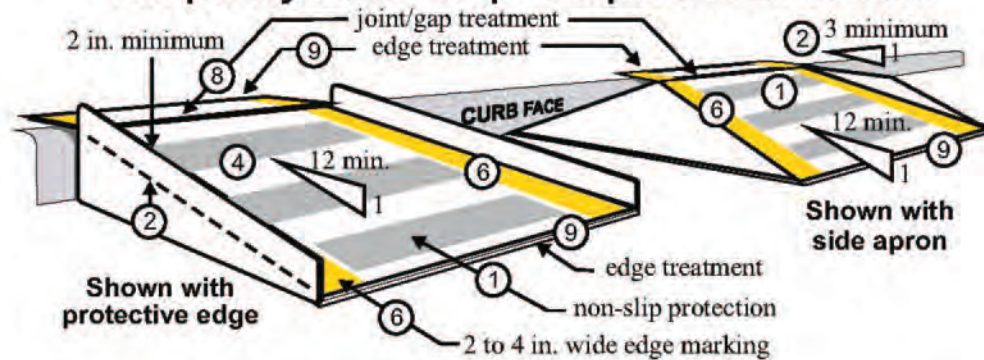

Figure 11. Specifications for MnDOT Type IV Barricade for Use on a Temporary Pedestrian Access Route

### Temporary Curb Ramp - Parallel to Curb



### Temporary Curb Ramp - Perpendicular to Curb



**NOTES:**

1. Curb ramps shall be 48 in. minimum width with a firm, stable and non-slip surface.
2. Protective edging with a 2 in. minimum height shall be installed when the curb ramp or landing platform has a vertical drop of 6 in. or greater or has a side apron slope steeper than 1:3 (33%). Protective edging should be considered when curb ramps or landing platforms have a vertical drop of 3 in. or more.
3. Detectable edging with 6 in. minimum height and contrasting color shall be installed on all curb ramp landings where the walkway changes direction (turns).
4. Curb ramps and landings should have a 1:50 (2%) max cross-slope.
5. Clear space of 48 x 48 in. minimum shall be provided above and below the curb ramp.
6. The curb ramp walkway edge shall be marked with a contrasting color 2 to 4 in. wide marking. The marking is optional where color contrasting edging is used.
7. Water flow in the gutter system shall have minimal restriction.
8. Lateral joints or gaps between surfaces shall be less than 0.5 in. width.
9. Changes between surface heights should not exceed 0.5 in. Lateral edges should be vertical up to 0.25 in. high, and beveled at 1:2 between 0.25 in. and 0.5 in. height.

### Typical ADA Pedestrian Devices

Refer to the Mn/DOT TPAR website for additional standards, guidance, and options for designing temporary pedestrian access routes.  
<http://www.dot.state.mn.us/trafficeng/workzone/tpar.html>

Figure 12. Minnesota DOT Specifications for Temporary Curb Ramps



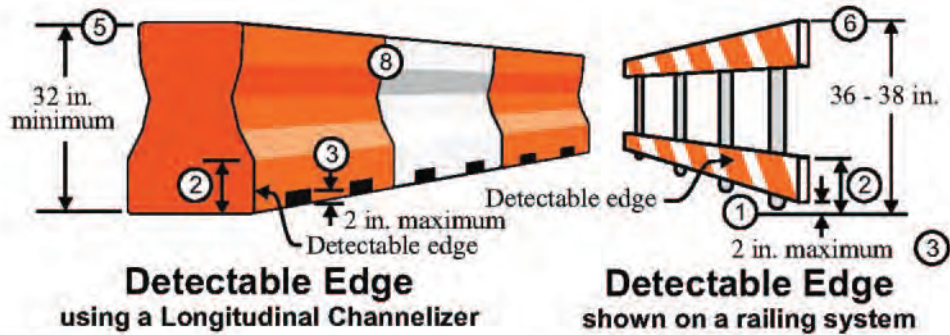

**NOTES:**

1. To prevent any tripping hazard to pedestrians, ballast shall be located behind or internal to the device. Any support on the front of the device shall not extend into the 48 in. minimum walkway clear space and shall have 0.5 in. maximum height above the walkway surface with approved beveling (see note #9 on page 6K-xxxii for beveling details).
2. Detectable edges for long canes shall be continuous and 6 in. min high above the walkway surface and have color or markings contrasting with the walkway surface.
3. Devices shall not block water drainage from the walkway. A gap height or opening from the walkway surface up to 2 in. maximum height is allowed for drainage purposes.
4. Railings or other objects may protrude a maximum of 4 in. into the walkway clear space when located 27 in. minimum above the walkway surface.
5. Longitudinal channelizing devices for pedestrians shall be 32 in. high or greater.
6. When hand guidance is required, the top rail or top surface shall:
  - be in a vertical plane perpendicular to the walkway above the detectable edge,
  - be continuous at a height of 36 to 38 in. above the walkway surface, and
  - be supported with minimal interference to the pedestrian's hands or fingers.
7. All devices shall be free of sharp or rough edges, and fasteners (bolts) shall be rounded to prevent harm to hands, arms or clothing of pedestrians.
8. All devices used to channelize pedestrian flow should interlock such that gaps do not allow pedestrians to stray from the channelized path.
9. Any pedestrian devices used to provide positive protection (traffic or hazard) for pedestrians or workers shall meet crashworthy requirements appropriate for the barriers' application.



**Typical ADA Pedestrian Devices**

Refer to the Mn/DOT TPAR website for additional standards, guidance, and options for designing temporary pedestrian access routes.  
<http://www.dot.state.mn.us/trafficeng/workzone/tpar.html>

**Figure 13. Minnesota DOT Specifications for Detectable Edging and Detectable Sidewalk Barricades**

## **SAMPLE Specification from Minnesota for Pedestrian Access in Work Zones**

This work shall consist of providing Temporary Access Control Plan. This plan shall consist of identifying a Temporary Pedestrian Accessible Route (TPAR) and features needed to assist pedestrian, bicyclists and non-motorized vehicles safe movement within and around the construction zone. This work shall be done in accordance with Contract provisions and the following:

S-270.1 The Contractor shall develop and provide for a continuous Temporary Pedestrian Accessible Route (TPAR) for this Project. The TPAR shall clearly address all non-motorized users in the construction zone. The Contractor shall submit this plan to the Engineer for acceptance at the pre-construction meeting.

### **S-270.2 PEDESTRIAN ACCESS**

(A) The TPAR must have a minimum width of 48 inches (4 feet) and guide pedestrians through and/or around the Project by using devices such as signage, barricades, and temporary curb ramps or blended transitions. The Contractor may provide an alternate route that is accessible and within \_\_\_ block(s) offset (*Leave blank for the project engineer to choose the allowable distance offset for the detour*) of the closed construction area. To the maximum extent feasible, the TPAR shall be provided on the same side of the street as the disrupted route. Where the TPAR is exposed to adjacent construction, excavation drop-offs, traffic, or other hazards, it shall be protected with a pedestrian barricade or channelizing device. All TPARs must have a smooth, level, slip-resistant surface and shall meet the applicable requirements of the Public Right-of-Way Accessibility Guidelines (PROWAG).

(B) The Contractor shall schedule and coordinate the replacement of the pedestrian access to accommodate the needs of the business and residences. Existing sidewalks shall be left in-place until such time that it is required to remove them to accommodate new construction. Pedestrian access may be provided to businesses be provided to buildings without alternate public entrances. Where disrupted by construction, the Contractor must provide a continuous TPAR for all areas disrupted construction throughout all phases of construction.

(C) For technical provisions on TPAR, the Contractor is directed to the Guidelines for Accessible Public Rights-of-Way at: <http://www.access-board.gov/prowac/draft.htm> and Chapter 6D of the MN MUTCD. The pedestrian accessibility checklist is on page 6D-5 and 6D-6 of the MN MUTCD. The Contractor shall complete MN MUTCD Fig. 6D-1, "Pedestrian Accessibility Considerations in Temporary Traffic Control Zones Check List". A copy shall be provided to the Engineer at the pre-construction meeting.

(D) The Contractor shall notify the Engineer in writing at least 72 hours prior to the start of any construction operation that will necessitate a change in pedestrian access. S-270.3 Traffic control devices must allow for an accessible route through the Project. TPAR pedestrian barricades and channelizing devices shall be continuous, stable, and non-flexible and shall consist of a wall, fence, or enclosures. The base of any traffic control devices shall be a continuous raised barrier of no more than 6 inches in height and must allow for drainage. The purpose of this barrier is to provide a continuous wayfinding device for the visually impaired, therefore the barrier shall not have any points that might catch a person who is using a cane for a guide. The Devices shall provide a continuous surface or upper rail at a minimum 3 feet above the ground or walkway surface. Support members shall not protrude into the path. Whenever possible the TPAR shall only utilize in-place street crossings. TPAR must be regularly inspected and updated depending on Project staging.

S-270.4 No pedestrian curb ramp or blended transition work shall occur concurrently at adjacent intersections. *Removed sentence, but we want to use S-.8 on all jobs with curb ramps on them. The idea is that the contractor will stage work so that work only occurs on one side of the street and at every other intersection*

S-270.5 The Contractor shall be responsible for maintaining the TPAR within this Project. The Contractor shall

furnish the name, addresses, and phone number of at least one individual responsible for the placement and maintenance of TPAR. This individual shall be “on call” 24 hours per day, seven days per week during the times any devices, furnished and installed by the Contractor, are in place. The required information shall be submitted to the Engineer at the pre-construction meeting. S-270.5 The Contractor shall be responsible for maintaining the TPAR within this Project. The Contractor shall furnish the name, addresses, and phone number of at least one individual responsible for the placement and maintenance of TPAR. This individual shall be “on call” 24 hours per day, seven days per week during the times any devices, furnished and installed by the Contractor, are in place. The required information shall be submitted to the Engineer at the pre-construction meeting.

The Contractor shall be expected to answer calls immediately and begin corrective measures needed within one hour. **If the Contractor is negligent in correcting the deficiency within one hour of notification the Contractor shall be subject to a monetary deduction at the rate of \$100.00 per hour when only one residence or location is affected and at the rate of \$500.000 per hour in all other cases that the Engineer determines the Contractor has not complied.**

#### ***Use if needed***

S-270.6 No closures for sidewalk or pedestrian curb ramp or blended transition related work are allowed along route between the hours of X -X AM and X-X PM.

#### ***Use if needed***

S-270.7 The Contractor is advised that the corridor has Transit service. Re-locations of stops can only be made with the approval of the Engineer. The Contractor is hereby directed to Section S-1707 (PUBLIC CONVENIENCE AND SAFETY) of these Special Provisions.

#### ***Use ON ALL PROJECTS THAT HAVE PED RAMP RECONSTRUCTION***

S-270.8 Only one side of the roadway may be disrupted at a time for pedestrian curb ramp, blended transition, or sidewalk construction. Where it is not feasible to provide a same-side TPAR and pedestrians will be detoured, the alternate route must provide a similar level of accessibility to the existing route. This may include the incorporation of accessible pedestrian signals (APS), curb ramps, or other accessibility features.

#### ***Use with pay item***

S-270.9 No measurement will be made of the various items that constitute Temporary Pedestrian Access Control, but all such work shall be construed to be included in the lump sum payment under Item 2563.601 (Temporary Pedestrian Access Control). The lump sum payment shall be compensation in full for all costs of furnishing, installing, maintaining and removing the individual devices.

#### ***Use without pay item***

S-270.10 All traffic control required under this Contract for pedestrian access shall be performed as incidental work for which no direct payment will be made.

# Appendix C. Florida Standard 660 Pedestrian Control For Closure of Sidewalks

The following general notes reference the 3 sample design drawings for Florida DOT

1. Only the signs controlling pedestrian flows are shown. Other work zone signs will be needed to control traffic on streets.
2. For spacing of traffic control devices and general TCZ requirements refer to Index No. 600. Maximum spacing between barricades, vertical panels, drums or tubular markers shall not be greater than 25 feet.
3. Street lighting should be considered.
4. For nighttime closures use Type A flashing warning lights on barricades supporting signs and closing sidewalks. Use Type C steady-burn lights on channelizing devices separating the work area from vehicular traffic.
5. Pedestrian traffic signal display controlling closed crosswalks shall be covered or deactivated.
6. Post Mounted Signs located near or adjacent to a sidewalk shall have a 7 foot minimum clearance from the bottom of sign to the sidewalk.
7. When Construction activities involve sidewalks on street, efforts should be made to stage the construction so that both sidewalks are not out of service at the same time.
8. In the event that sidewalks on both sides of the street are closed, pedestrians shall be guided around the construction zone.
9. Temporary walkways shall be a minimum of 4 feet wide with a maximum 0.02 cross slope and a maximum 0.05 running slope between ramps. Temporary walkways less than 5 feet wide in width shall provide for a 5 foot by 5 foot passing space at intervals not to exceed 200 feet. Temporary walkway surfaces and ramps shall be stable, firm, slip resistant, and kept free of any obstructions and hazards such as holes, debris, mud, construction equipment, stored materials, etc.
10. Temporary ramps and temporary crosswalk markings shall be removed with reopenings of the sidewalk, unless otherwise noted in the plans. All work and materials associated with constructing temporary curb ramps and temporary crosswalk markings, removal disposal of temporary curb ramps and temporary crosswalk markings, and restoration to original condition shall be paid for as Maintenance of Traffic, Lump Sum.

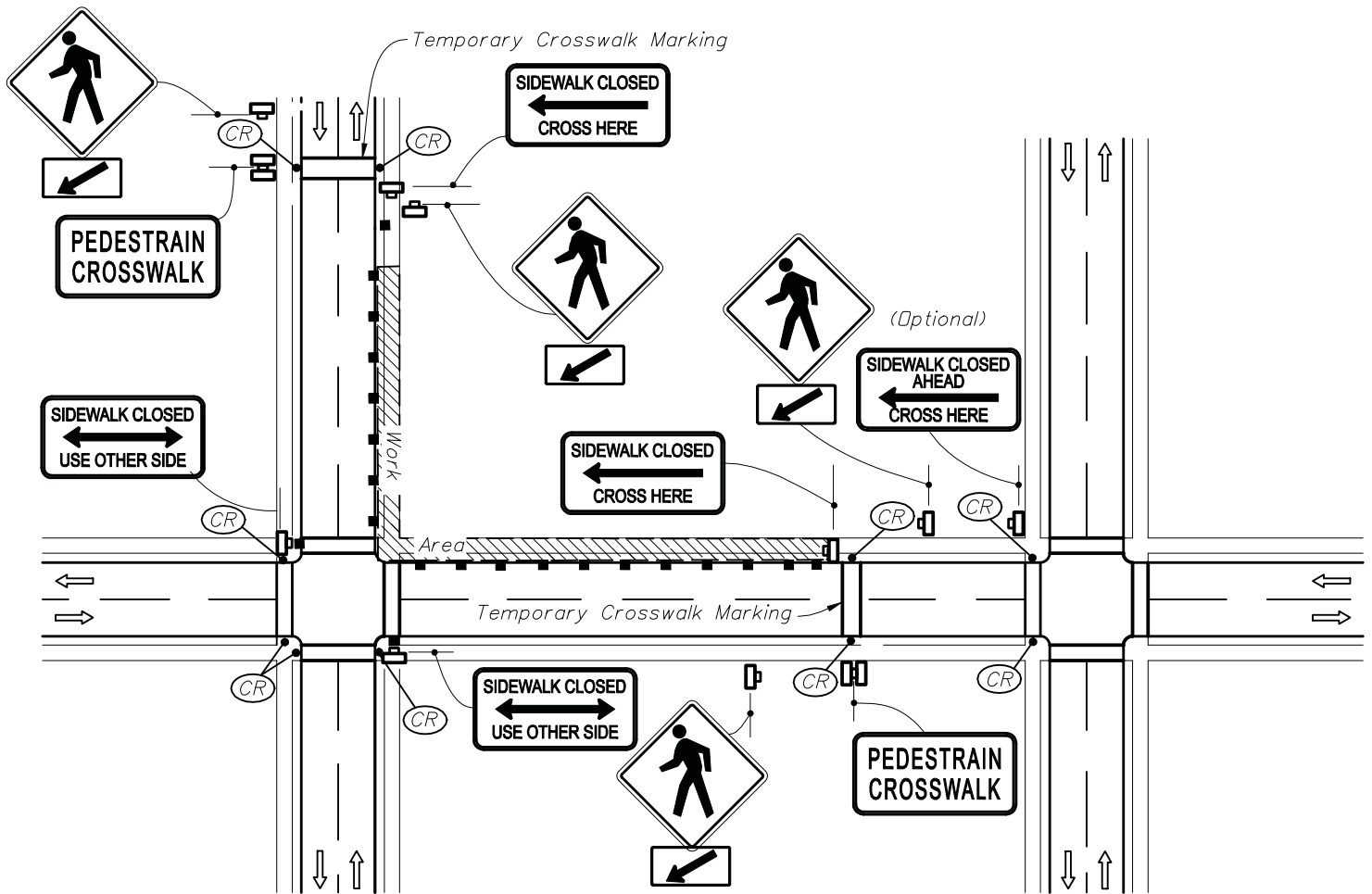
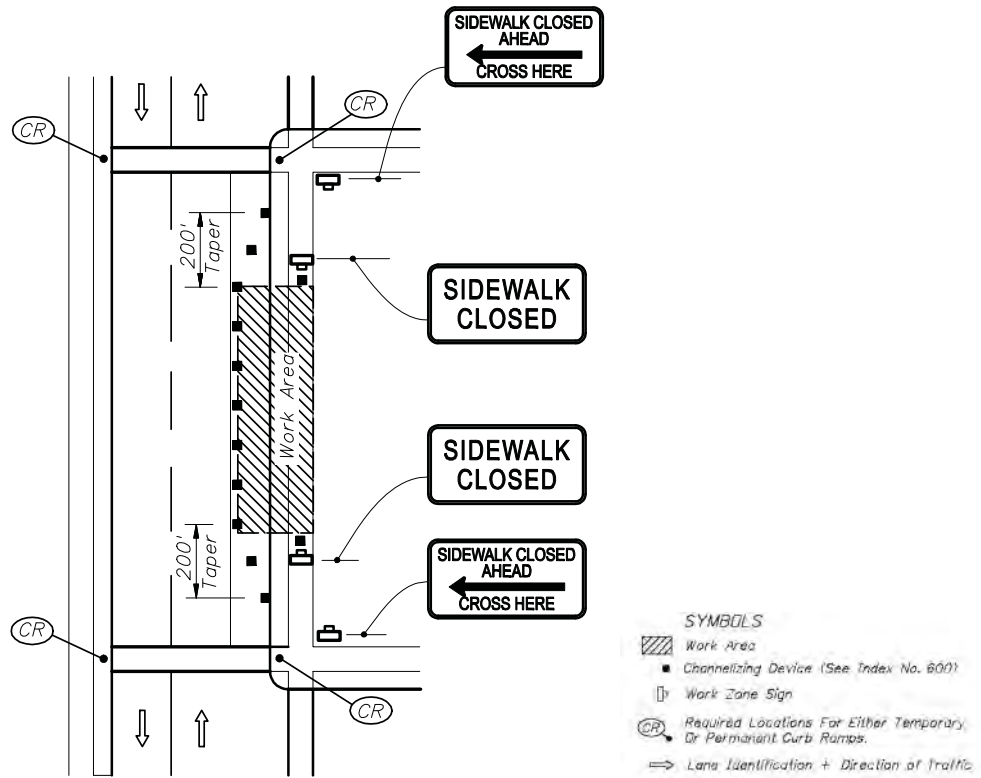
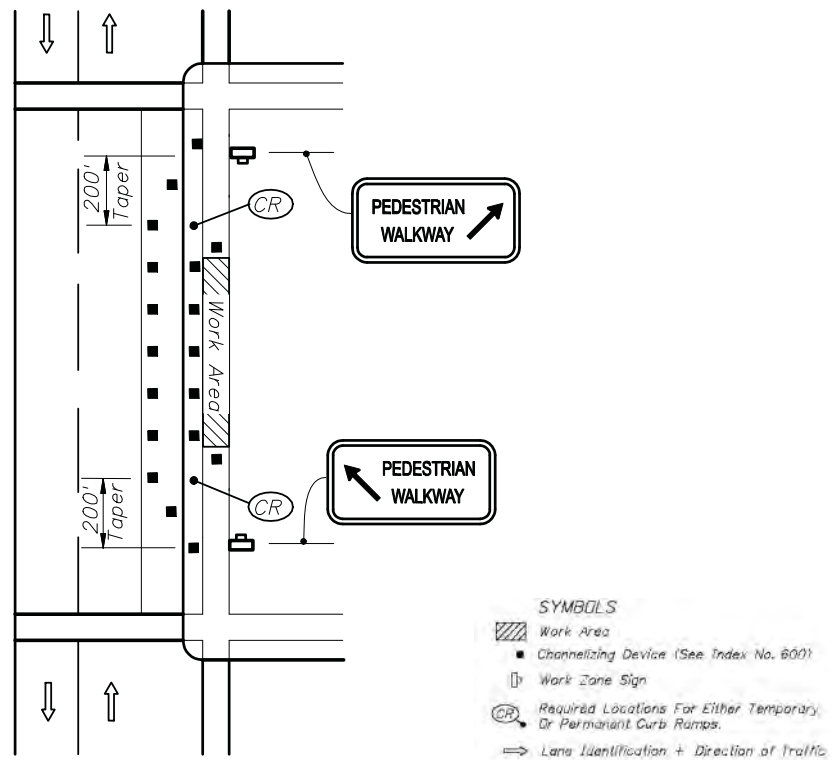

Figure 14. Corner Sidewalk Closure with Temporary Crosswalks



**Figure 15. Florida Standard 660: Pedestrian Control for Closure of Sidewalks**



**Figure 16. Florida standard 660: Pedestrian Control For Closure of Sidewalks - Mid-Block Sidewalk Closure with Temporary Walkway**

# Appendix D. Oregon Department of Transportation Design Guidance and Sample Layout

The following is design guidance that Oregon Department of Transportation provides to their engineers on ADA specific requirements.

- For specifications, Oregon provides guidance by providing them information to use and tailor to the individual work zone. The information that they provide includes what information to provide and where to pull the information:
  - i. For all sidewalk or sidewalk ramp closures
    - a. Install signs as shown on standard drawings. Mount signs between the panels of the type II barricade or, if installed on single-post TSS, locate the signs behind type II barricades
    - b. Close the sidewalk at a point where there is an alternate way to proceed or provide an alternate pedestrian route
    - c. Pave the alternate pedestrian route surface or provide an approved, non-slip 48 inch minimum wide surface meeting the requirements of the American with Disabilities Act (ADA).
    - d. When utilizing a temporary pedestrian access route, protect pedestrians by installing pedestrian channelizing devices (PCD) along both sides of the route. The temporary pedestrian access route is to remain open until the pedestrian facility is reopened.
    - e. Reopen the sidewalk during non-work hours or continue to provide an alternate route for pedestrians.
    - f. Provide alternate pedestrian routes that match existing facilities and provide additional TCM to meet the accessibility requirements in Part VI of the MUTCD.
  - ii. “Add the following subsection **Specification X: Pedestrian Channelizing Device**-Use PCD from the QPL and as shown on the standard drawings.
  - iii. “Add the following subsection: **Specification X: Pedestrian Channelizing Device** – Install PCD as shown. Provide a continuous route by interconnecting all adjacent PCD.
  - iv. “Add the following subsection: **Specification X: Pedestrian Channelizing Device** – the quantities of pedestrian channelizing devices will be measured on the unit basis.
  - v. **Specification X: Temporary Barricades, Guardrail, Barrier, and Attenuators** – Add the following pay item to the end of the pay item list: Pedestrian Channelizing Devices...Each
- Oregon also provides a set of standard drawings to use. These drawings help the designer’s layout a particular sidewalk closure and provide some general notes to use.

## **Oregon Standard Drawings**

General Notes for the following drawings include:

- When closing or relocating crosswalks or other pedestrian facilities provide ADA compliant facilities. Include accessibility features consistent with existing pedestrian facilities by providing adequate slope transitions and surfacing.
- Only TCD for pedestrians are shown. Other devices may be necessary to control vehicular traffic.
- Stage work, as necessary, to provide a temporary pedestrian access route at all times. For roadways with no available detours, maintain one open sidewalk at all times.
- Minimize pedestrian out-of-directional travel.

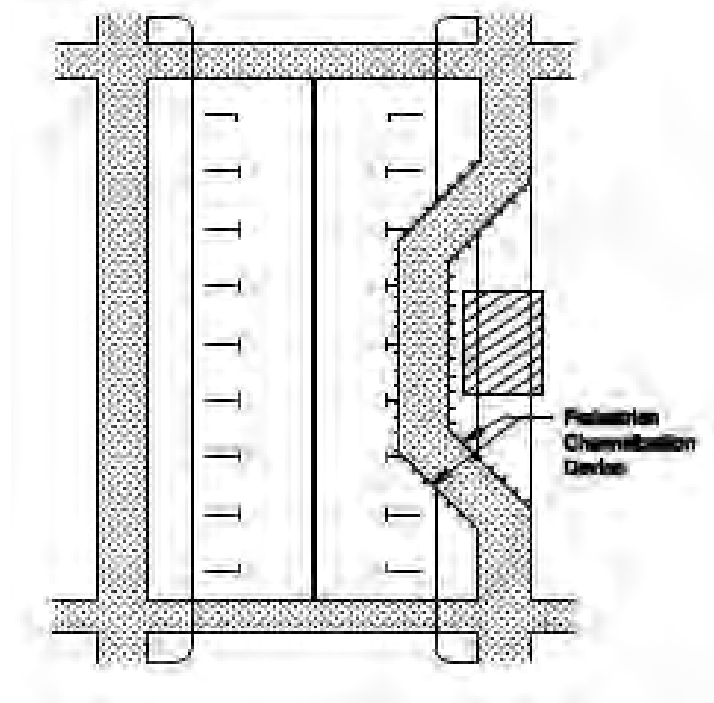

Figure 17. Roadway Sidewalk Diversion for Low Speed Roads (< 40 mph)

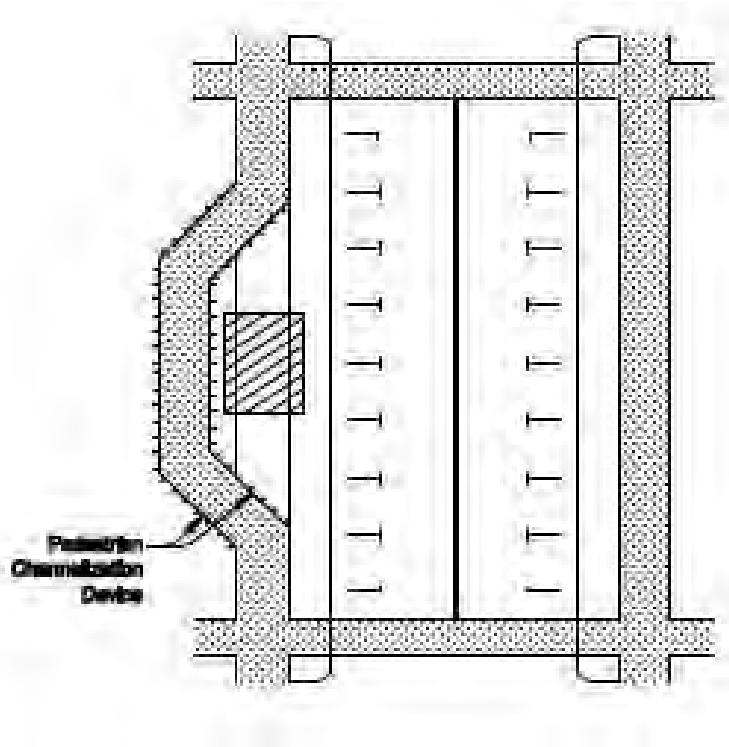

Figure 18. Right of Way Sidewalk Diversion



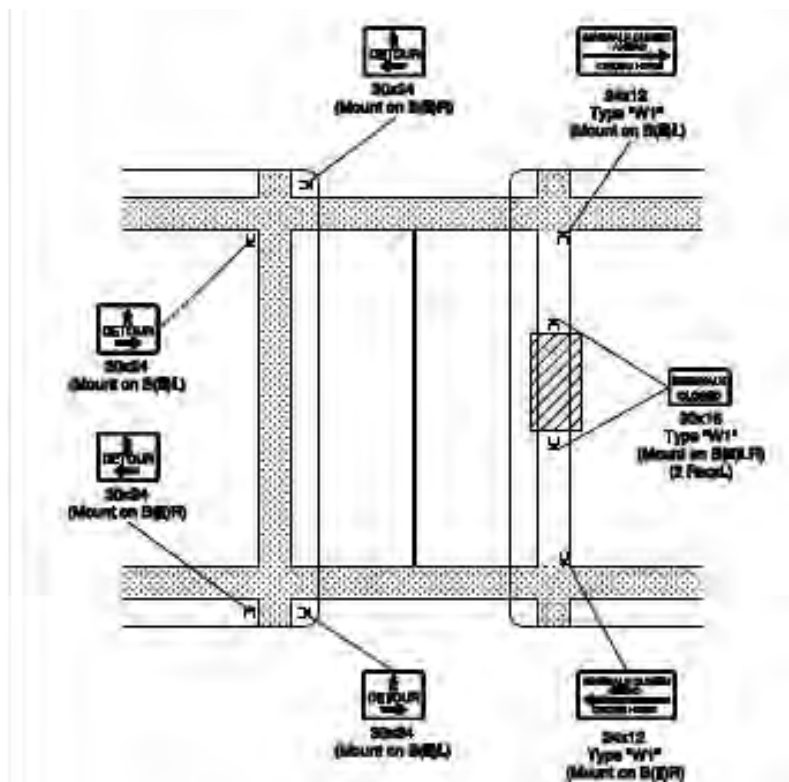
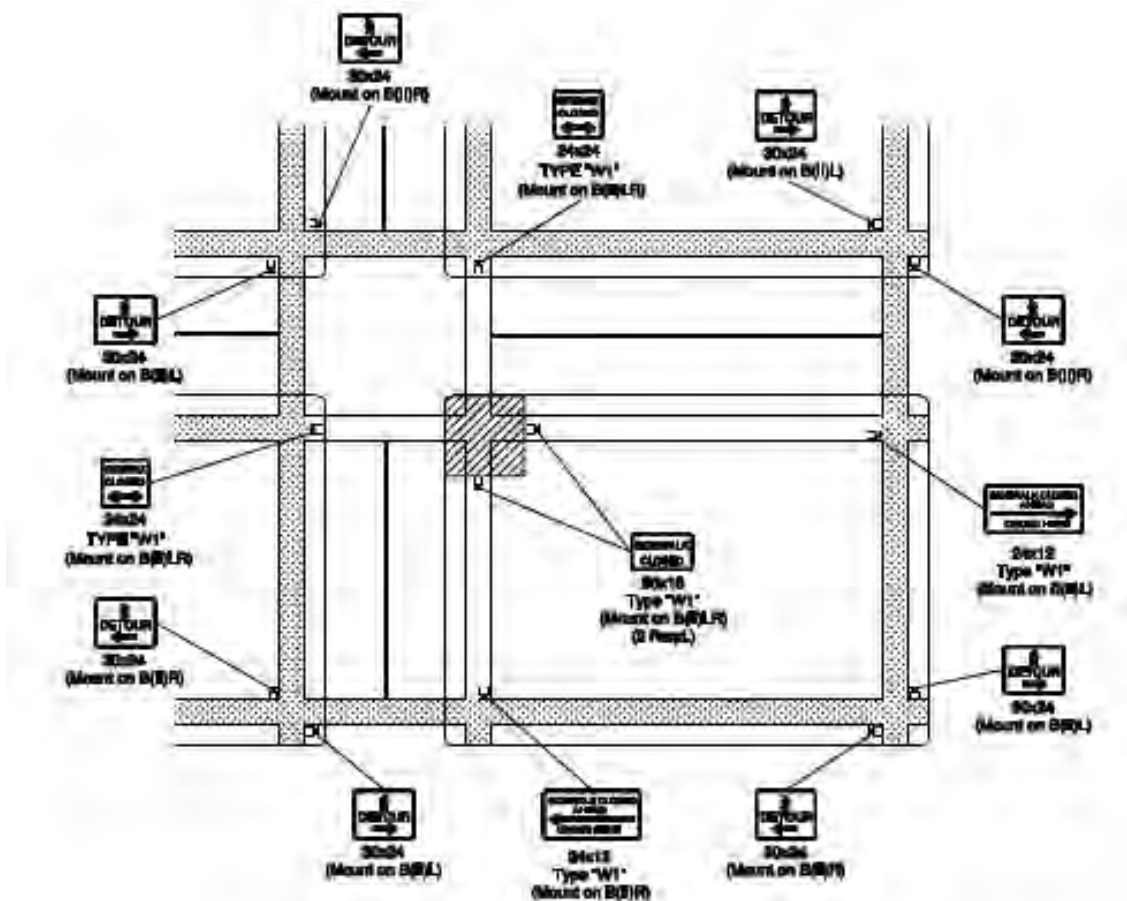

Figure 19. Mid-Block Sidewalk Closure



Note: Limit work to one corner at a time to minimize the pedestrian disruption.

Figure 20. Corner Sidewalk Closure

# Appendix E. Washington State Department of Transportation Design Guidance

## 1510.17 Work Zone Pedestrian Accommodation<sup>1</sup>

Providing access and mobility for pedestrians through and around work zones is an important design concern, and it must be addressed in the temporary traffic control plans if the project occurs in a location accessible to pedestrians. The designer must determine pedestrian needs in the proposed work zone during the public input process and through field visits.

In work zones:

- Separate pedestrians from conflicts with work zone equipment and operations.
- Separate pedestrians from traffic moving through or around the work zone.
- Provide pedestrians with alternate routes that have accessible and convenient travel paths that duplicate, as closely as feasible, the characteristics of the existing pedestrian facilities.

Provide walkways that are clearly marked and pedestrian barriers that are continuous, rigid, and detectable to vision-impaired persons who navigate with a cane. Also, keep:

- The pedestrian head space clear.
- Walkways free from pedestrian hazards such as holes, debris, and abrupt changes in grade or terrain.
- Access along sidewalks clear of obstructions such as construction traffic control signs.
- A minimum clear width path throughout: 4 feet for pedestrians or 10 feet for pedestrians and bicyclists.

Temporary pedestrian facilities within the work zone must meet accessibility criteria to the maximum extent feasible.

Consider the use of flaggers if pedestrian generators such as schools are in the work zone vicinity. Consider spotters who are prepared to help pedestrians through the work zone.

Provide for advance public notification of sidewalk closures in the contract special provisions and plans.

Where transit stops are affected or relocated because of work activity, provide an accessible route to temporary transit stops.

<sup>1</sup> WSDOT Design Manual 22-01.08 dated July 2011 access at <http://www.wsdot.wa.gov/publications/manuals/fulltext/M22-01/1510.pdf>

# Appendix F. Sample Americans with Disabilities Act (ADA) Drawings

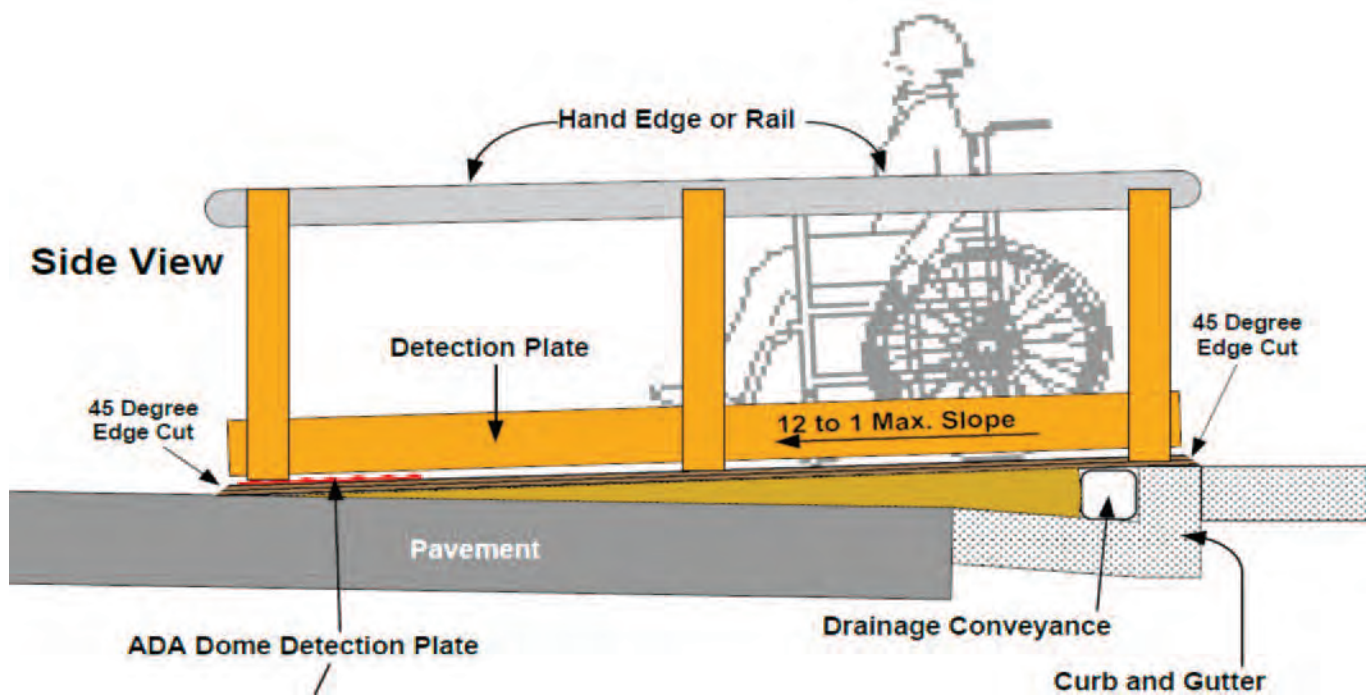

Figure 21. Pedestrian/ADA Detour Path – Temporary Ramp into the Roadway



**The American Traffic Safety Services Association**

15 Riverside Parkway, Suite 100  
Fredericksburg, VA 22406-1022  
800-272-8772



U.S. Department of Transportation  
**Federal Highway Administration**